

SFT-40-WES Gen 2

High Power White LEDs

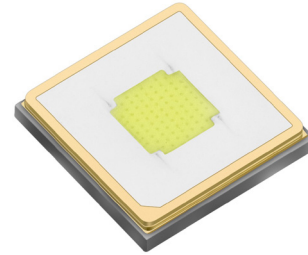

Features

SFT white series is a powerful light source for beam pattern critical lighting applications. The flat window of an SFT white LED results in a much smaller light emitting surface than a dome-shaped cover, enabling smaller optics and higher optical efficiency in directional lighting systems.

- Vertical chip with high lumen density and small emitting angle, ideal for efficient optical beam shaping to achieve high intensity, narrow beam angle and long beam distance.
- Phosphor-on-chip with superior color uniformity over radiation angles, delivering homogeneous color in beam spots.
- Maximum Drive Current: 8 A
- Color Temperature: 5000K, 5700K, 6500 K
- Color Rendering Index: Typ. 73 (5000K, 5700K), Typ. 70 (6500K)
- Low thermal resistance: 0.7°C/W
- ANSI-compatible chromaticity bins
- Electrically isolated thermal path
- 8 kV HBM ESD rating per ANSI/ESDA/JEDEC JS-001



Applications

- Portable Lights
- Bicycle Lights
- Automotive Auxiliary Lights
- LED Work Lights
- Outdoor and Roadway Lighting
- High Bay Industrial Lighting
- Entertainment Lighting
- Directional Light Fixtures

Table of Contents

Ordering Information.	2
Binning Structure.	3
Absolute Maximum Ratings	6
Characteristics	6
Soldering Profile.	9
Mechanical Dimensions.	10
Tape and Reel Outline	11
Shipping Label	12
Packaging.	13
Notes	14



Ordering Information

Ordering Part Numbers¹

CRI	CCT	Luminous Flux		Chromaticity Bin Kit Code ³	Ordering Part Numbers
		Minimum Flux Bin ¹	Minimum Flux ²		
Min. 70	5000K	F8	610 lm	501	SFT-40-WE50-F2-F8501
				502	SFT-40-WE50-F2-F8502
		F9	640 lm	501	SFT-40-WE50-F2-F9501
				502	SFT-40-WE50-F2-F9502
	5700K	F8	610 lm	571	SFT-40-WE57-F2-F8571
				572	SFT-40-WE57-F2-F8572
		F9	640 lm	571	SFT-40-WE57-F2-F9571
				572	SFT-40-WE57-F2-F9572
Typ. 70 Min. 65	6500K	F8	610 lm	651	SFT-40-WS65-F2-F8651
				652	SFT-40-WS65-F2-F8652
				703	SFT-40-WS65-F2-F8703
		F9	640 lm	651	SFT-40-WS65-F2-F9651
				652	SFT-40-WS65-F2-F9652

Part Number Nomenclature

SFT

40

W<yxx>

F<#>

<ffccc>

Product Family	Chip Area	Color	Package Configuration	Bin Kit
S: Surface Mount F: Flat Window T: Single Emitter	40: 4.0 mm ²	W: White <y> CRI Category Code E: CRI > 70 S: CRI > 65 <xx> Color Temperature 50: 5000K 65: 6500K	F: Package Code <#> Chip Generation 2: Gen 2	<ff> Minimum Flux Bin, see 'Luminous Flux Binning' table for details <ccc> Chromaticity Bin Kit, see 'Chromaticity Bin Kit Codes' table for details

Note:

- The Ordering Part Number specifies the Minimum Flux Bin in shipment; higher flux bins may be shipped without advance notice. Please refer to 'Luminous Flux Binning' table for details of all flux bins.
- Product test condition: I_f=1500 mA, T_j=85°C.
- Shipments always adhere to the color bins specified in each Chromaticity Bin Kit. See 'Chromaticity Bin Kit Codes' table for the color bins included in each Bin Kit.



Binning Structure

Luminous Flux Binning^{1,2}

Flux Bin Code	Binning @ 1500 mA			Correlated Minimum Flux (lm) @ $T_j=85^{\circ}\text{C}^2$			
	$T_j=85^{\circ}\text{C}$		$T_j=25^{\circ}\text{C}$				
	Minimum Flux (lm)	Maximum Flux (lm)	Minimum Flux (lm)	700 mA	3000 mA	6000 mA	8000 mA
F7	580	610	650	290	1038	1757	2123
F8	610	640	683	305	1092	1848	2233
F9	640	680	717	320	1146	1939	2342
G1	680	720	762	340	1217	2060	2489
G2	720	760	806	360	1289	2182	2635

Forward Voltage Binning³

Voltage Bin Code ³	Binning @ 1500 mA, $T_j=85^{\circ}\text{C}$	
	Minimum Voltage (V)	Maximum Voltage (V)
VH	2.5	2.7
VJ	2.7	2.9
VK	2.9	3.1

Note:

1. LEDs are measured at 25°C ambient temperature with 1500 mA 20 ms single pulse. The measured values are correlated to values at 85°C junction temperature (T_j). Luminus maintains a $\pm 6\%$ tolerance on flux measurement.
2. Flux values at other junction temperature (T_j) and/or forward current conditions are calculated and for reference only.
3. Individual voltage bins are not orderable.



Binning Structure

Chromaticity Binning Coordinates

CCT	Bin Code	CIE _x	CIE _y	Bin Code	CIE _x	CIE _y	Bin Code	CIE _x	CIE _y	Bin Code	CIE _x	CIE _y
5000K	DA	0.3371	0.3490	DB	0.3376	0.3616	DC	0.3463	0.3687	DD	0.3451	0.3554
		0.3451	0.3554		0.3463	0.3687		0.3551	0.3760		0.3533	0.3620
		0.3440	0.3427		0.3451	0.3554		0.3533	0.3620		0.3515	0.3487
		0.3366	0.3369		0.3371	0.3490		0.3451	0.3554		0.3440	0.3427
	DH	0.3366	0.3369	DE	0.3381	0.3762	DF	0.3480	0.3840	DG	0.3440	0.3428
		0.3440	0.3428		0.3480	0.3840		0.3571	0.3907		0.3515	0.3487
		0.3429	0.3307		0.3463	0.3687		0.3551	0.3760		0.3495	0.3339
		0.3361	0.3245		0.3376	0.3616		0.3463	0.3687		0.3429	0.3307
5700K	CA	0.3215	0.3350	CB	0.3207	0.3462	CC	0.3290	0.3538	CD	0.3290	0.3417
		0.3290	0.3417		0.3290	0.3538		0.3376	0.3616		0.3371	0.3490
		0.3290	0.3300		0.3290	0.3417		0.3371	0.3490		0.3366	0.3369
		0.3222	0.3243		0.3215	0.3350		0.3290	0.3417		0.3290	0.3300
	CH	0.3222	0.3243	CE	0.3196	0.3602	CF	0.3290	0.3690	CG	0.3290	0.3300
		0.3290	0.3300		0.3290	0.3690		0.3381	0.3762		0.3366	0.3369
		0.3290	0.3180		0.3290	0.3538		0.3376	0.3616		0.3361	0.3245
		0.3231	0.3120		0.3207	0.3462		0.3290	0.3538		0.3290	0.3180
6500K	BA	0.3048	0.3207	BB	0.3028	0.3304	BC	0.3115	0.3391	BD	0.3130	0.3290
		0.3130	0.3290		0.3115	0.3391		0.3205	0.3481		0.3213	0.3373
		0.3144	0.3186		0.3130	0.3290		0.3213	0.3373		0.3221	0.3261
		0.3068	0.3113		0.3048	0.3207		0.3130	0.3290		0.3144	0.3186
	BH	0.3068	0.3113	BE	0.3005	0.3415	BF	0.3099	0.3509	BG	0.3144	0.3186
		0.3144	0.3186		0.3099	0.3509		0.3196	0.3602		0.3221	0.3261
		0.3161	0.3059		0.3115	0.3391		0.3205	0.3481		0.3231	0.3120
		0.3093	0.2993		0.3028	0.3304		0.3115	0.3391		0.3161	0.3059
7500K	AA	0.2950	0.297	AB	0.2920	0.3060	AC	0.2984	0.3133	AD	0.2984	0.3133
		0.2920	0.306		0.2895	0.3135		0.2962	0.3220		0.3048	0.3207
		0.2984	0.3133		0.2962	0.3220		0.3028	0.3304		0.3068	0.3113
		0.3009	0.3042		0.2984	0.3133		0.3048	0.3207		0.3009	0.3042
	AH	0.2980	0.2880	AE	0.2895	0.3135	AF	0.2962	0.3220	AG	0.3037	0.2937
		0.2950	0.2970		0.2870	0.3210		0.2937	0.3312		0.3009	0.3042
		0.3009	0.3042		0.2937	0.3312		0.3005	0.3415		0.3068	0.3113
		0.3037	0.2937		0.2962	0.3220		0.3028	0.3304		0.3093	0.2993



Binning Structure

Chromaticity Binning Diagram¹

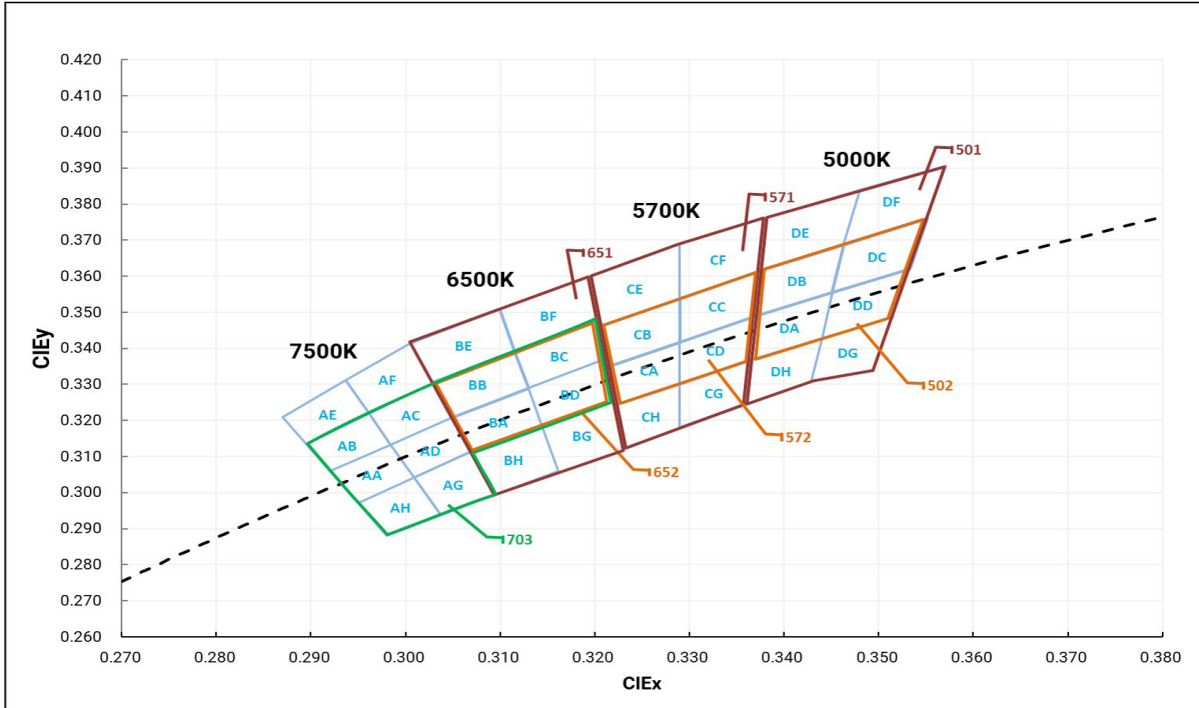

Chromaticity Bin Kit Codes

CCT	Bin Kit	Chromaticity Bins
5000K	501	DA, DB, DC, DD, DE, DF, DG, DH
	502	DA, DB, DC, DD
5700K	571	CA, CB, CC, CD, CE, CF, CG, CH
	572	CA, CB, CC, CD
6500K	651	BA, BB, BC, BD, BE, BF, BG, BH
	652	BA, BB, BC, BD
6500K - 7500K	703	AA, AB, AC, AD, AG, AH, BA, BB, BC, BD

Note:

- LED chromaticity is measured and binned at 25°C ambient temperature with 1500 mA 20 ms single pulse.
- Luminus maintains a tolerance of ±0.005 on Chromaticity (CIE_x, CIE_y) measurement.



Absolute Maximum Ratings

Parameter		Symbol	Values	Unit
DC Forward Current	Minimum	$I_{f\ min}$	0.1	A
	Maximum	$I_{f\ max}$	8.0	
Surge Current (t<10 ms, Duty Cycle < 10%)		I_s	10.0	A
Reverse Voltage (@ $I_f = 10\ mA$)		V_r	5	V
Power Dissipation		P_D	29	W
Junction Temperature		T_j	150	°C
Operating Temperature Range		T_{opr}	-40 to 100	°C
Storage Temperature Range		T_{stg}	-40 to 100	°C
ESD withstand Voltage HBM Per ANSI/ESDA/JEDEC JS-001		V_{HBM}	8	kV
ESD withstand Voltage CDM Per ANSI/ESDA/JEDEC JS-002		V_{CDM}	1	kV

Characteristics

Parameter		Symbol	Value		Unit
			WS	WE	
Color Rendering Index ¹ ($T_j = 85^\circ\text{C}$)	Minimum	CRI_{\min}	65	70	
	Typical	CRI_{typ}	70	-	
Viewing Angle (FWHM)		$2\theta_{1/2}$	120		°
Forward Voltage ($I_f = 1500\ mA, T_j = 85^\circ\text{C}$)	Minimum	$V_{f\ \min}$	2.5		V
	Typical	$V_{f\ \text{typ}}$	2.8		
	Maximum	$V_{f\ \max}$	3.1		
Temperature Coefficient of Voltage		$\partial_{V_f}/\partial_T$	-1.3		mV/°C
Thermal Resistance (Electrical) Junction/Solder Point		$R_{\text{thjs-EL}}$	0.7		°C/W

Note:

1. Luminus maintains a tolerance of ± 2 on Color Rendering Index (CRI) measurement.



Relative Luminous Flux

Forward Current: $\phi_v/\phi_v(1.5\text{ A}), T_j = 85^\circ\text{C}$

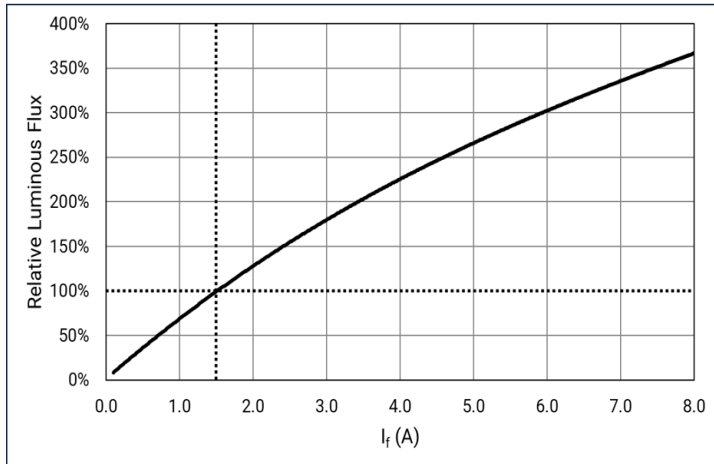

Temperature (T_j): $\phi_v/\phi_v(85^\circ\text{C}), I_f = 1.5\text{ A}$

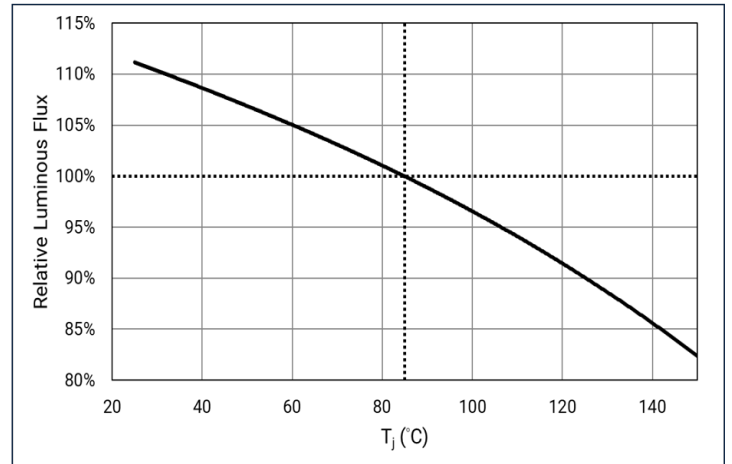

Forward Voltage

Forward Current: $\Delta V_f = V_f(I_f) - V_f(1.5\text{ A}), T_j = 85^\circ\text{C}$

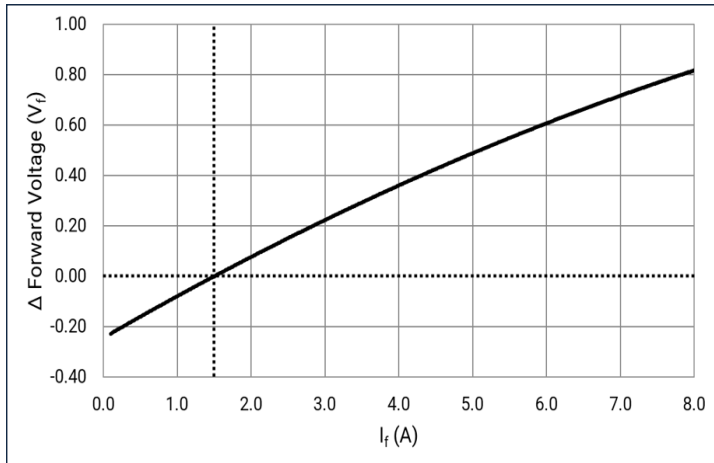

Temperature (T_j): $\Delta V_f = V_f(T_j) - V_f(85^\circ\text{C}), I_f = 1.5\text{ A}$

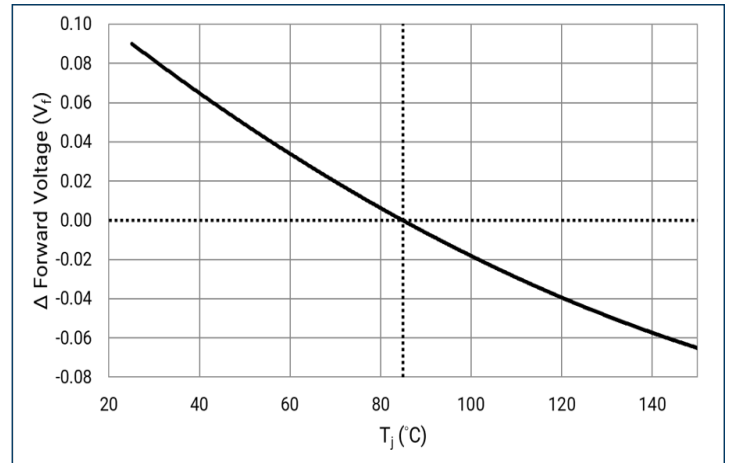

Relative Chromaticity

Forward Current: $\Delta \text{CIEx,y} = \text{CIEx,y}(I_f) - \text{CIEx,y}(1.5\text{ A}), T_j = 85^\circ\text{C}$

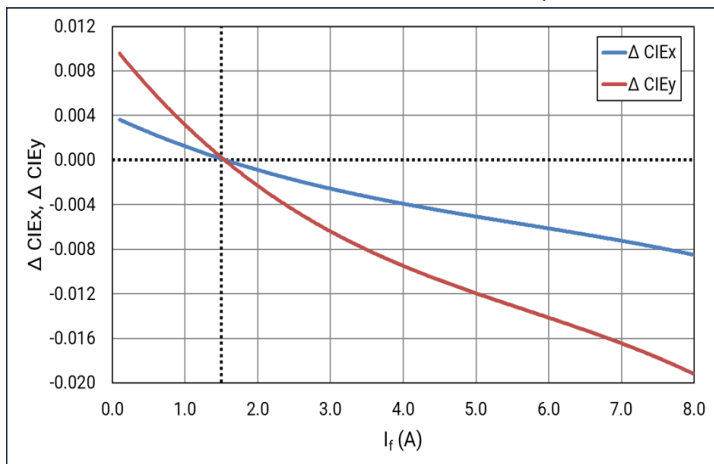

Temperature (T_j): $\Delta \text{CIEx,y} = \text{CIEx,y}(T_j) - \text{CIEx,y}(25^\circ\text{C}), I_f = 1.5\text{ A}$

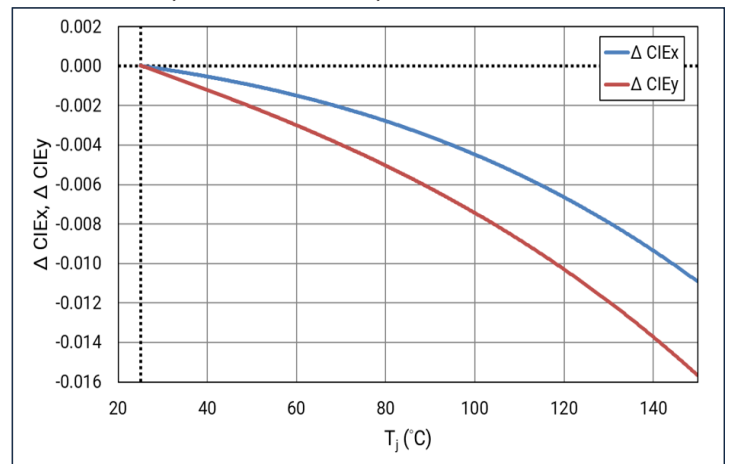



Angular Distribution

$I_f = 1.5 \text{ A}; T_j = 25^\circ\text{C}$

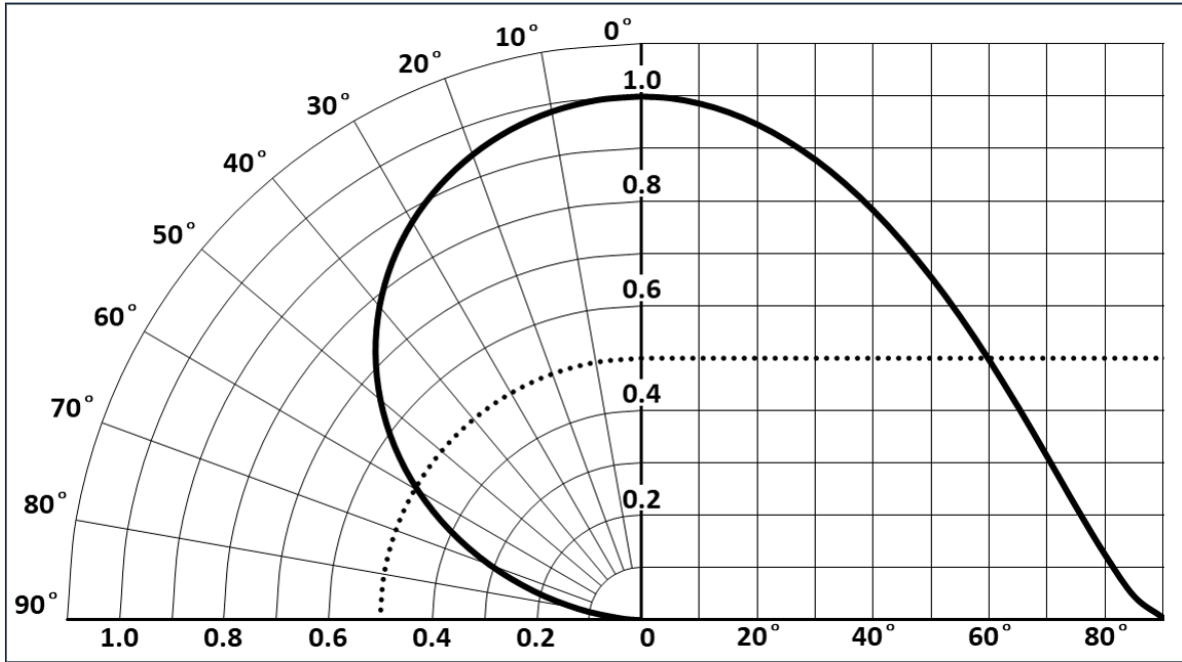

Relative Spectral Power Distribution

$I_f = 1.5 \text{ A}; T_j = 85^\circ\text{C}$

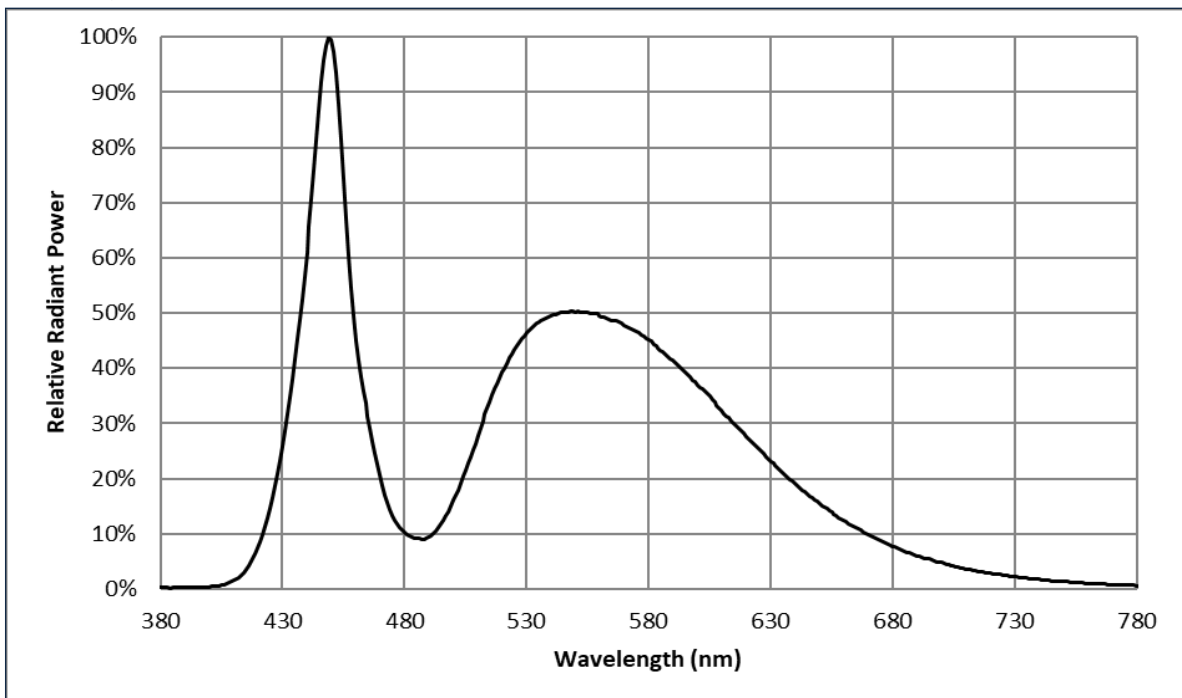



Soldering Profile

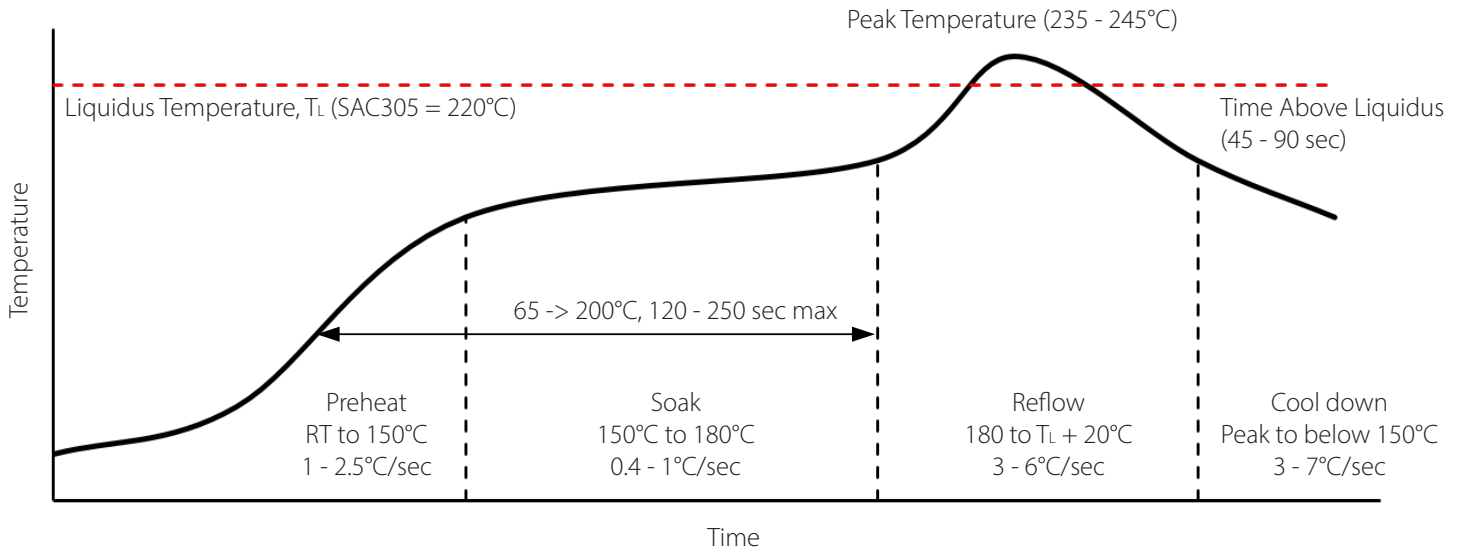

SMT Rework Guideline	Manual Hotplate Reflow	Hot Air Gun Reflow
Heating Time		< 60 sec
Hotplate Temperature	< 245°C	< 150°C

Note:

- Product complies to Moisture Sensitivity Level 3 (MSL 3).
- The numbers in the table are specific to SAC305. Luminus recommends using an SAC305 solder paste with a no-clean flux for RoHS compliant products.
- During the pick and place process, axial forces on the dome (or window) should not exceed 0.5 Newtons (N).
- Use of a multi-zone IR reflow oven with a nitrogen blanket is recommended.
- Time-temperature profile of the reflow process showing the four functional profile zones are defined in IPC-7801. Temperature is referenced to the center of the PCB.
- Luminus recommends to use the solder paste data sheet information as a starting point in time-temperature process development.
- These are general guidelines. Consult the solder paste manufacturer's datasheet for guidelines specific to the alloy and flux combination used in your application.
For more information, please refer to:
<https://luminusdevices.zendesk.com/hc/en-us/articles/360060306692-How-do-I-Reflow-Solder-Luminus-SMD-Components->
- For any technical questions about soldering process, please contact Luminus at techsupport@luminus.com.



Mechanical Dimensions

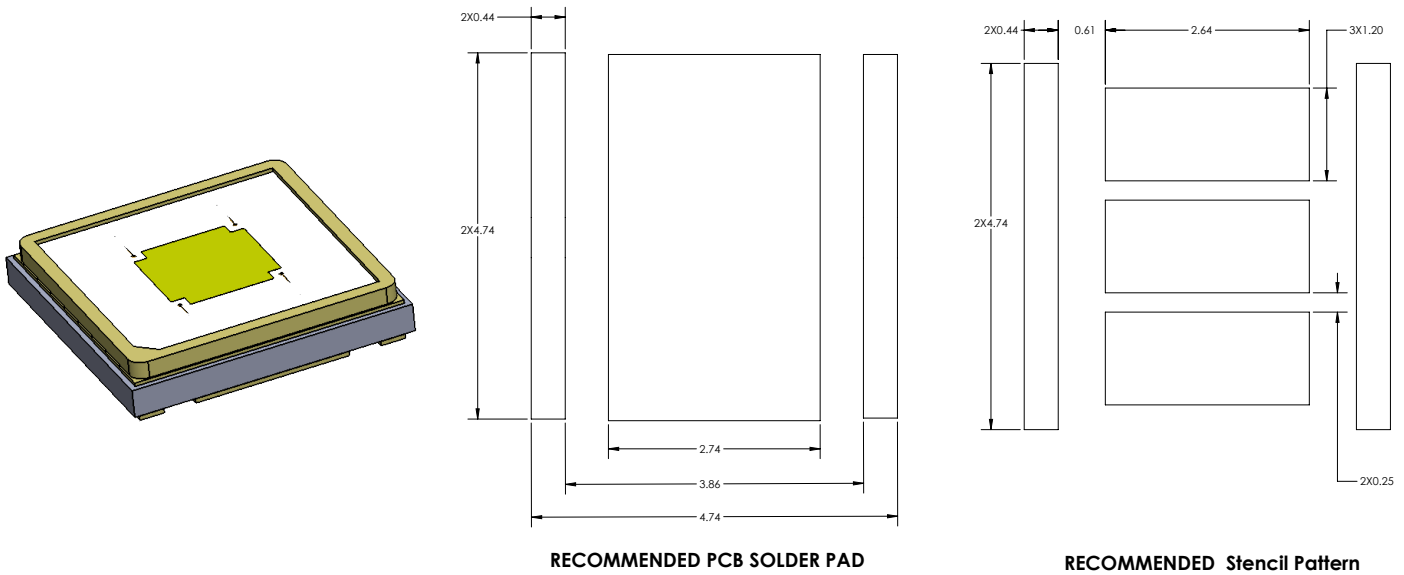
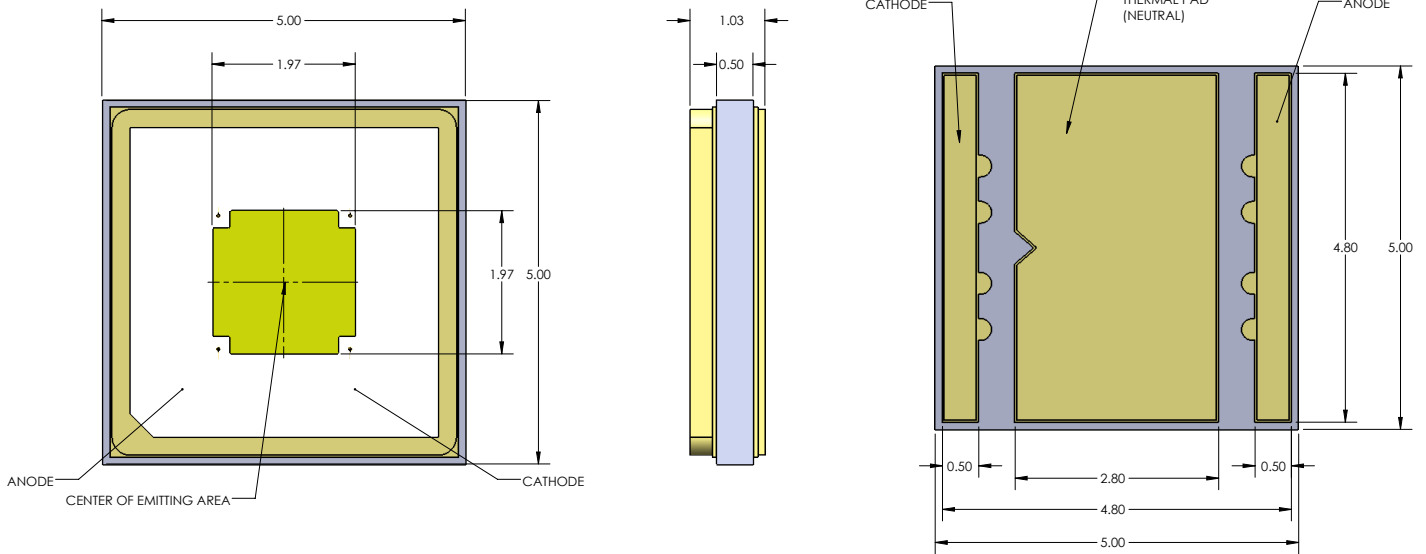

RECOMMENDED PCB SOLDER PAD

RECOMMENDED Stencil Pattern

Note:

1. All dimensions are in millimeter ± 0.13 mm.



Tape and Reel Outline

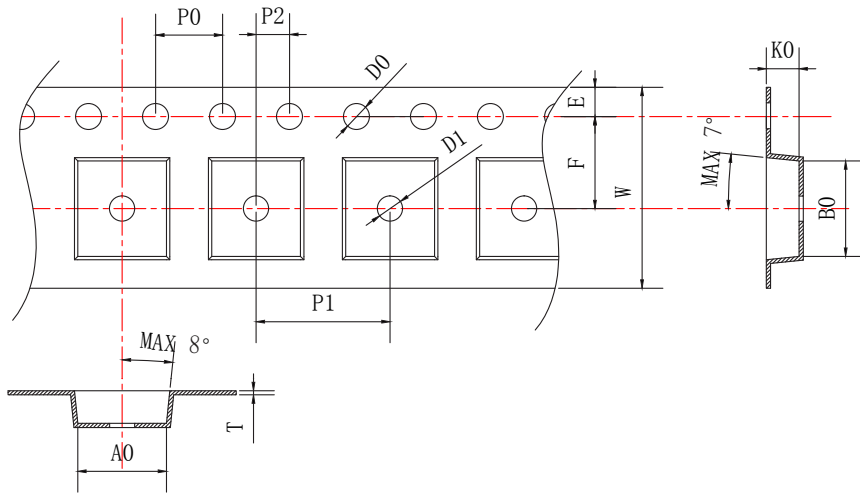

Parameter	Dimension (mm)
A0	5.3±0.1
B0	5.3±0.1
D0	1.5±0.1
D1	1.5±0.25
E1	1.75±0.1
F	5.5±0.1
K0	1.7±0.1
P0	4.0±0.1
P1	8.0±0.1
P2	2.0±0.1
T	0.25±0.02
W	12+0.3 12-0.1

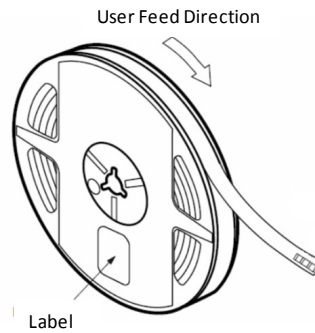
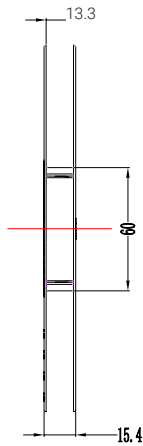
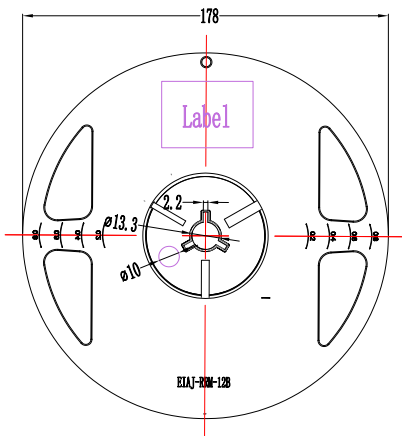

Note:

1. Each Reel contains 500 units of LEDs.
2. Black anti-static tape material (Denka ECM3/ECAP3)
3. The accumulated tolerance for ten chain holes should be no more than 0.2 mm.
4. The tortuosity of 250 mm tape should be no more than 1 mm.
5. Leave 800 mm of type empty for lead in (100 empty pockets)
6. Leave 1200 mm of type empty for trailer (150 empty pockets)
7. All dimensions must comply to EIA-481-D
8. Final tape and reel packaging must meet the requirements of JEDEC-STD-033, LEVEL 2A.



Shipping Label

Label on Packaging Box

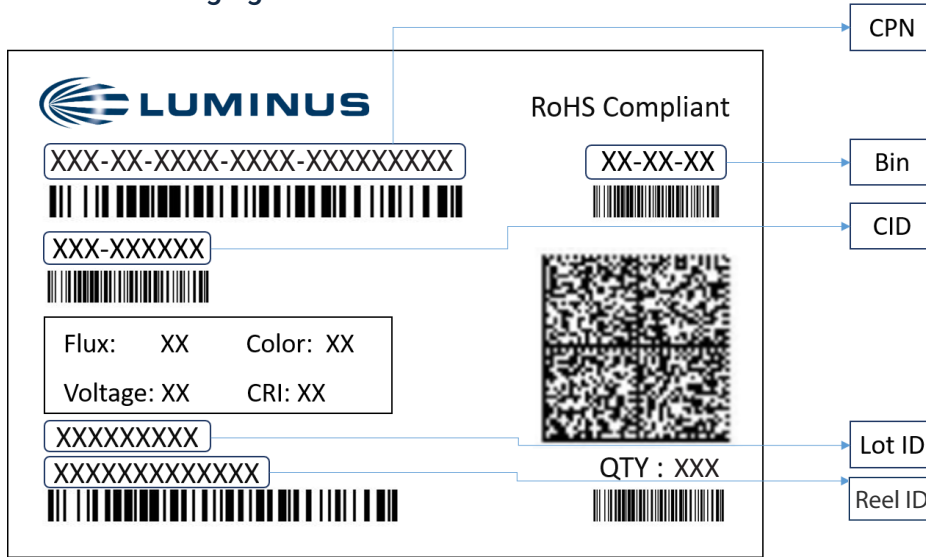

Label Fields:

- CPN: Luminus ordering part number
- CID: Customer's part number
- QTY: Quantity of parts per reel
- Flux: Bin as defined on page 3
- Voltage: Bin as defined on page 3
- Color: Bin as defined on page 4
- CRI: NA
- Lot ID & Reel ID: For Luminus internal use

Label on Reel

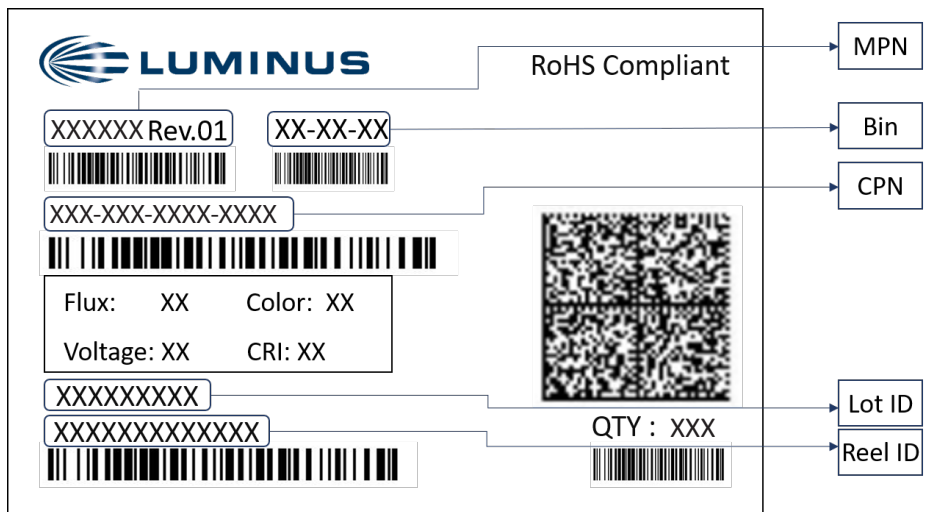

Label Fields:

- CPN: Luminus ordering part number
- MPN: For Luminus internal use
- QTY: Quantity of parts per reel
- Flux: Bin as defined on page 3
- Voltage: Bin as defined on page 3
- Color: Bin as defined on page 4
- CRI: NA
- Lot ID & Reel ID: For Luminus internal use



Packaging

Packaged Reel

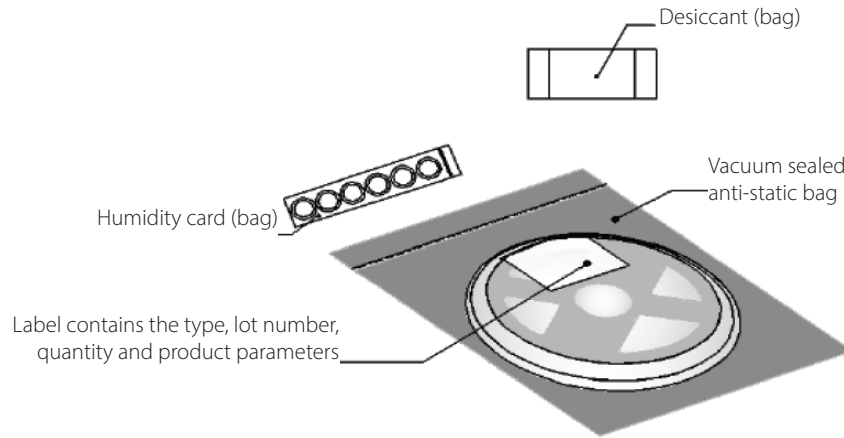

Packaging boxes

Box Size 1 - 5 reels per box
Size: 22.5 x 24.5 x 6.5 cm

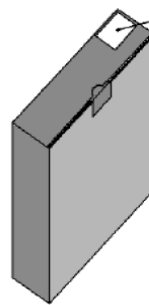
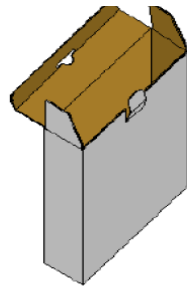

Label contains the type, lot number, quantity and product parameters

*Capacity 5 reels per box

Box Size 2 - 10 reels per box
Size: 22.5 x 24.5 x 13 cm

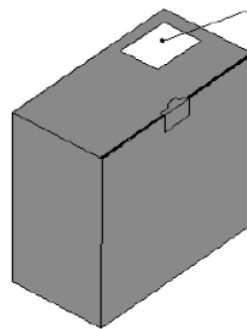
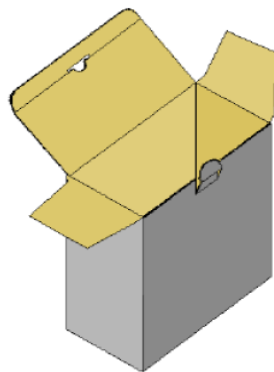

Label contains the type, lot number, quantity and product parameters

*Capacity 10 reels per box

Packing Configuration:

- 500 units per reel
- Each reel is enclosed in anti-static bag
- Shipping label is placed on top of each reel
- Multiple labels are attached to the box (one label per reel inside the box)



Notes

Static Electricity

1. The products are sensitive to static electricity, and care should be taken when handling them.
2. Static electricity or surge voltage will damage the LEDs. It is recommended to wear anti-electrostatic gloves or wristband when handling the LEDs.
3. All devices, equipment and machinery must be properly grounded. It is recommended that measures be taken against surge voltage to the equipment that mounts the LEDs.

Reference: [APN-002815](#) Electrical Stress Damage to LEDs and How to Prevent It

Storage

1. Before opening the package

The LEDs should be kept at a temperature lower than 40°C and relative humidity lower than 90%. The LEDs should be used within a year. When storing the LEDs, moisture proof package with absorbent material (silica gel) is recommended.

2. After opening the package

The LEDs should be kept at a temperature lower than 30°C and relative humidity lower than 60%. The LEDs should be soldered within 168 hours (7 days) after opening the moisture proof package.

If unused LEDs remain, they should be stored in moisture proof packages, such as sealed containers with moisture absorbent material (silica gel). It is also recommended to return the unused LEDs to the original moisture proof package and to seal it again.

If the moisture absorbent material (silica gel) vaporizes or passes the expiration date, baking treatment should be performed by using the following conditions : 60°C for 20 hours.

The LED's electrode and lead frame comprise a silver plated copper alloy. The silver surface may be affected by environments. Please avoid conditions which may cause the LEDs to corrode or discolor. The corrosion or discoloration might lower solderability or affect optical characteristics.

Please avoid rapid transition in ambient temperature, especially in high humidity environments where condensation can occur.